



GREENWIT TECHNOLOGIES Inc.

OFFICIAL SUPPLIER OF MOTORINO™ PRODUCTS

SPARE PARTS CATALOG

PARTS for Motorino XMa

February, 2016

















Motorino XMa Parts















Colors













RED	Red
GRE	Grass Green
YELL	Lemon Yellow







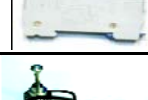
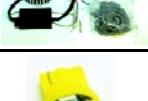



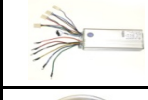

XMa - Body and Trim

Part#	Picture	Description	Colors
MAP01		Headlight Bezel	BLK
MAP02 L / R		Side Faring Panel [specify Left or Right]	GRE, RED or YELL
MAP03		Front Fender	GRE, RED or YELL
MAP04 L / R		Front Fender Bracket [specify Left or Right]	BLK
MAP05		Fairing Box Reverse [Painted]	GRE, RED or YELL
MAP06		Floorboard Perimeter (blk)	BLK
MAP07 L / R		Lower side panel [specify Left or Right]	GRE, RED or YELL
MAP08 L / R		Upper side panel [specify Left or Right]	GRE, RED or YELL
MAP09		Battery Access Cover (blk)	BLK
MAP10 L & R		Chainguard [specify Left or Right]	GRE, RED or YELL
MAP22		Rear Under Panel	BLK
MAP23		Rear Fender	BLK
MAP24		Rear Panel [Painted]	GRE, RED or YELL
MAT01		Two-tone hook	

Part#	Picture	Description
MAP11		Dash Housing (blk)
MAP12		Fairing box front
MAP13		Fairing Box Reverse [lower]
MAP14		Fairing Box Reverse Upper
MAP15		XMa Dash Bezel
MAP16		Underseat Panel (with charging terminal opening)
MAP17		Under Seat Bucket Splash Guard
MAP19 L & R		Side Panel (battery tray sidecover) [specify Left or Right]
MAP20		Rear Headlight Housing
MAP21		Seat Bucket
MAT03		Silver Floorboard Trim
MAT04		Battery lock swivel cover
TR12L / TR12R		XMa Mirror
MAT02		Seat















XMa- Electrical

Part#	Picture	Description
MAE01		Headlight Assembly
MAE02		Dashboard (with clear cover but w/o black bezel and housing)
NE03		Left Switch Cluster
NE04		Right Switch Cluster
MAE05		Turnsignal [Front & Back same]
MAE06		Taillight
MAE09		Ignition
EL19		Turnsignal Relay
EL119		Alarm w. 2 remotes
EL31		Brake light, Clear, 12V, bayonet, dual filament, 5/10W, offset pins
EL21		12V Horn
EL22		40A Breaker
EL120		LED Headlight Bulb, w/ mounting hardware
EL78		Turn Signal bulb LED 12v t10 8smd yellow wedge base

Part#	Picture	Description
EL12L		Brake Switches Lefthand (hammer style)
EL12R		Brake Switches Righthand (hammer style)
EL24		Male Charging Terminal
EL116		60v CCt Controller
MOT027		Full Disc Motor Assembly (see Assemblies for details) (60V winding)
EL09		Throttle
EL10		Companion handle
EL11		CCT switch
EL18		60V-12V DC converter
EL28-25W		12V 25W Headlight Bulb, Skirt (XMa / XPv / XPr)
BAT07		Alarm remote battery
EL29-AMB		Xma Signal Bulb, 12V 10W, single filament, AMBER, wedge base
EL40		40A Wire lengths (set of 4)





XMa- Mechanical





Part#	Picture	Description
MAM01		Handlebar
MAM02		upper triple clamp with lower bar mount
MAM03		Steering column and lower triple clamp
MAM04		Front bracket (mounts dash, headlight & signals)
MAM05		Upper Handlebar Mounts (pair)
MAM06		Front Wheel
DM03L DM03R		Brake Handle (hydraulic) Specify Left or Right
MC17		ABS Nipple Coupler
MC37		Front Hydraulic Line
HR64		x2 Hydraulic Banjo bolt
MC34		Rear Hydraulic Line
MAM07L MAM07R		Front shock absorbers
MAM12		Battery Hold-down Bracket
MAM13		Dashboard Bracket
MAM14		License Plate Bracket

Part#	Picture	Description
MC15		ABS Front hydraulic regulator [c/w ABS Coupler Nipple]
MC16		ABS Rear hydraulic regulator [c/w ABS Coupler Nipple]
MAM17		Brake Mounting Plate
MC56		180mm Rear Disc Brake Rotor
MC50L MC50R		Disc Brake Master Cylinder Assembly, Tall Reservoir, incl. Lever & Switch, Chrome
EM17		Front Brake Caliper
MC20		Front Disc Brake pads
MC40R MC40S		Rear Brake Caliper [specify Red or Silver]
MC22		Rear Brake Pads
EM05		Front Brake Disc [Sub w/ VM05]
MC12		Pedals (L&R)
MC24		Folding Pedals [Pair]
TT01		3.5x10 tire (all XP models)
HM12		Main Kickstand
MC08		Rear Shock Absorber

[Continues...]









XMa- Mechanical [Cont.]









Part#	Picture	Description
MAM15L MAM15R		Rear aluminium handles [Specify Left or Right]
MAM16		Seat Latch
GM01L / GM01R		Foot Peg, Retractable
MAM19		Pedal Axle
MAM09		steering column endcap and washer

Part#	Picture	Description
MC13		Pedal cranks
MC14		Sprocket Freewheel
HM15		Side Kick Stand
MAM34		Rear Rack, Add-on, for Box Mount, Black [May require further bracing]
MC112		Front axle 12mm dia. *Spacer cut to spec

XMa - Hardware and Minor Parts





NOTE: Any minor parts which are elements of a larger assembly (motor, spare battery, rear box) are not listed here.

Part#	Picture	Description
HR03		Bearings -Steering Column
HR04		Bearings - Pedal Axle
HR06		Front Wheel Brake-Side Bearings (37mm/12mm)
HR07		Front Wheel Right-side Bearings (32mm/12mm)
???		Front wheel seal
HR18		spring - main kickstand
HR19		spring - side kickstand
HR22		Battery contact screw set (8 bolts, 8, lock washers, 8 washers)

Part#	Picture	Description
HR23		Panel screws
HR24		Panel screw clips
HR52		Ring terminal
HR25		M6x1.0 chromed bolt (on front fairing)
HR73		Xpv/s front caliper mounting bolt
HR31		Universal rear brake disk bolt, also front XPh disc
MC114		Front Axle spacer 12mm *Cut to Spec
HR72		Shock Mounting Bolt

[Continues...]

XMa - Hardware and Minor Parts [...Continued]

Part#	Picture	Description
HR43		M8x1.25 Rear Brake caliper Mounting Bolt
HR50		6x1.0 bolt (long)
HR56		Chain Master Link
TT11B		Tubeless Tire Valve Bent
AC18		License plate

Part#	Picture	Description
HR42		Sidestand Mounting Bolt M10x1.25 with 15mm collar
HR62		M5x0.8 nut (for connector block posts)
HR55		Bike Chain (specify precise length or # of links)
HR51		6x1.0 bolt (short)
HR44		M10x1.25 Main Kickstand Bolt w. collar